



Yuasa Fiche de données techniques

Yuasa M27-EFB - Batteries marines

Performance

Tension	12V
Capacité (20 heures)	90Ah
Performances en démarrage à froid (EN1)	700A

Dimensions

Longueur	304mm
Largeur	173mm
Hauteur	225mm



Poids & Mesures

Poids moyen avec acide	22.3kg
------------------------	--------

Caractéristiques du bac

Type de bac	GR27 BCI
Schéma de montage	1
Système de fixation	B1
Indicateur de l'état de charge	✓
Poignées	✓
Sortie(s) d'aération	✓
Caractéristiques semi-traction	✓
Type de couvercle	Double capot (anti-écoulement et sans entretien)

Technologie

Dispositif stop-flamme	✓
Technologie	Ca/Ca
Séparateur	PE
Taux de charge recommandé	6A

Type de bornes



Schéma de montage des éléments Système de fixation de la batterie



Date de publication: 02/07/2022 - E&OE

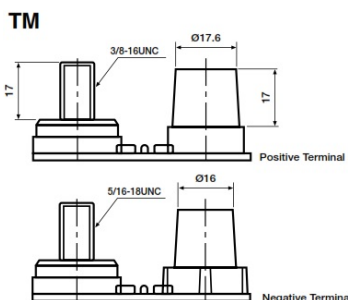
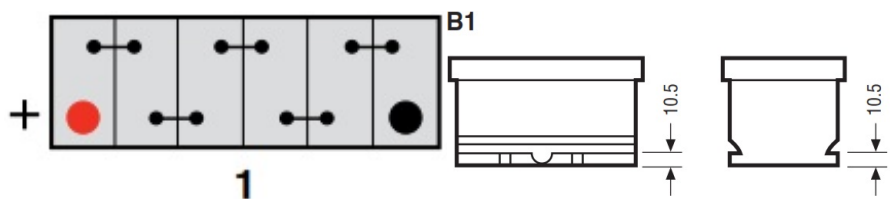

Yuasa Technical Data Sheet

Yuasa M27-EFB - Marine Batteries

Performance

Voltage	12V
Capacity (20-hour)	90Ah
Cold Cranking Amps (EN1)	700A

Dimensions

Length	304mm
Width	173mm
Height	225mm

Weights & Measures

Mean Weight with Acid	22.3kg
-----------------------	--------

Container Features

Case Type	GR27 BCI
Cell Layout	1
Hold Down	B1
State of Charge Indicator	✓
Handles	✓
End Venting	✓
Semi-Traction Features	✓
Lid Type	SMF Double Lid

Technology

Flame Arrestor	✓
Technology	Ca/Ca
Separator	PE
Recommended Charge Rate	6A

Terminal Type

Cell Assembly Layout

Battery Hold-down

Data Sheet generated on 02/07/2022 - E&OE